



**LARK**  
SaniModule

OASIS  
Premium SaniModule

# Lark SaniModule

The multifunctional SaniModule is ideal for a camping park or free-standing city toilets. Use of a high quality waterproof materials will allow you to enjoy the properties of such a perfect solution for a long time.

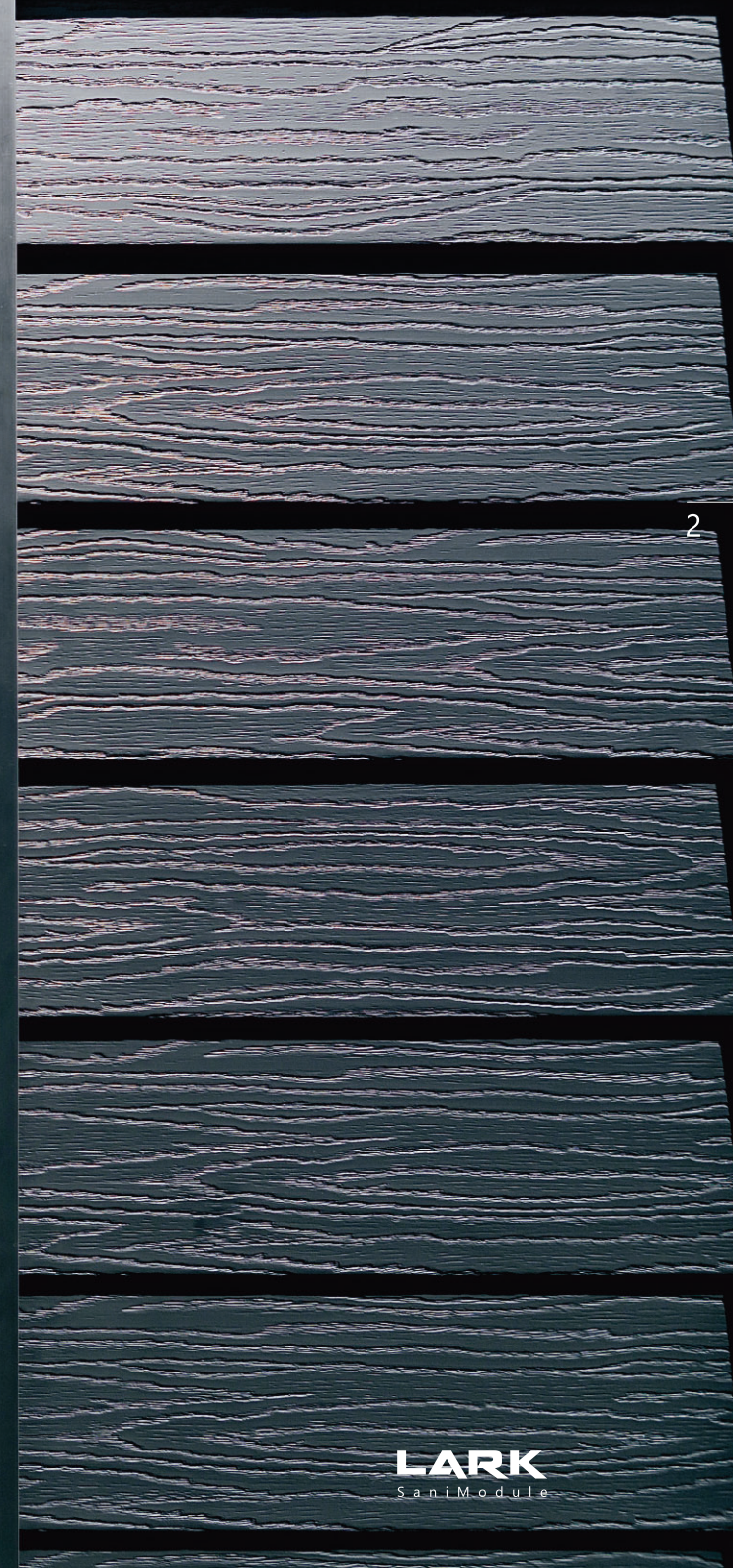



3

 **BALLUM**  
larkfactory.com

**LARK**  
SaniModule

# Facade

Extremely durable and resistant to changing weather conditions material, doesn't require regular maintenance, doesn't fade and doesn't change shape under the influence of sunlight and temperature.

A collection of claddings with an elegant, deep texture of real wood. It's a combination of a natural, authentic look with unmatched durability.



white

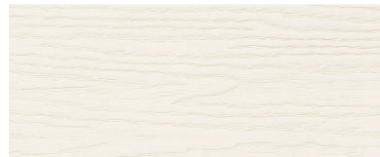

cream



beige



olive



light grey



grey



anthracite



Pest resistant



Easy to clean



Windproofness



Moisture resistant



Impact resistant



No painting and maintenance required



Lightness that facilitates installation and does not load the structure



Warranty



Ventilation of the facade



Easy to clean, thanks to the mill grinder, which allows free water drainage

# Roof

Polycarbonate plates are ideal for all types of roofing. Very resistant to impacts (they are almost 200 times more resistant than glass) and have a high coefficient of light transmission, which provides the opportunity to light the room.

- High resistance to mechanical damage and external loads
- Elasticity and flexibility
- High light transmission
- Lightness





## Doors

Metal entrance doors with a porthole and satinglass have increased resistance to moisture.



# Boiler room

The Ariston electric water heater is a smart device with a double water tank.

## ANTI-LEGIONELLA FUNCTION

Once a month, the water temperature rises automatically above 65 °C to eliminate bacteria and ensure water hygiene.

## ANTI-FRAUD SYSTEM

It protects the device against a temperature drop below 5 °C.

## SELF-DIAGNOSIS

In the event of a fault, an error code is displayed on the display to easily identify the cause.

## PROTECTION AGAINST STARTING "DRY"

In the event of a leak or lack of water in the device, it turns off the heater to prevent it from burning out.

## THE FUNCTION OF ACTIVE ELECTRICAL PROTECTION

After finishing the heating process, the heater is completely disconnected from the power supply to guarantee maximum safety.

## SMART touch panel BLUE-TECH

An intelligent and intuitive display for easy temperature management with information on water preparation for the first shower.



# Accessories

Hermetic sockets.



An external tap will allow you to connect a garden hose quickly.



The external outlet of hot and cold water together with the outflow gives the possibility of installing an external sink.



Handle for locking the door.





## Walls and floor

The walls and floor are made of high quality, waterproof HPL board, which thanks to its properties will allow a long time to maintain a fresh and new look of SaniModule Lark interior. In addition, covering the floor with a non-slip layer will take care of the maximum safety of users.

- resistant to abrasion
- impact resistant
- hygienic
- resistant to scratches
- antibacterial
- resistant to high temperature

HPL boards are very easy to keep clean. As a rule wiping them with a soft cloth and warm water is enough . If necessary, cleaners can be used.







KOLO

LARK  
SaniModule



# Permanent beauty bath ceramics

The one-piece monolithic shower cabin, made from the highest quality material, thanks to the integration of the walls with the shower tray, ensures excellent protection against leakage.

A wall-hung toilet and a countertop washbasin are elements of bathroom ceramics emphasizing high standard and unique style.



Bathroom fan

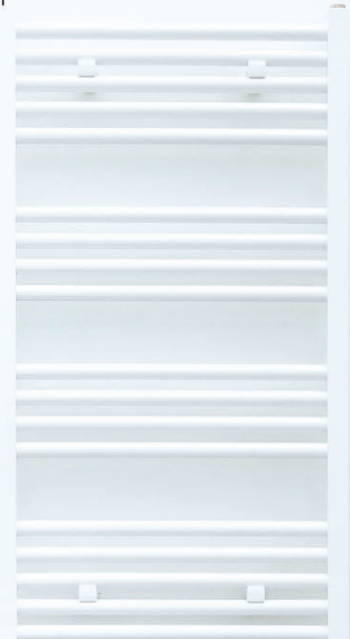



# Additional accessories

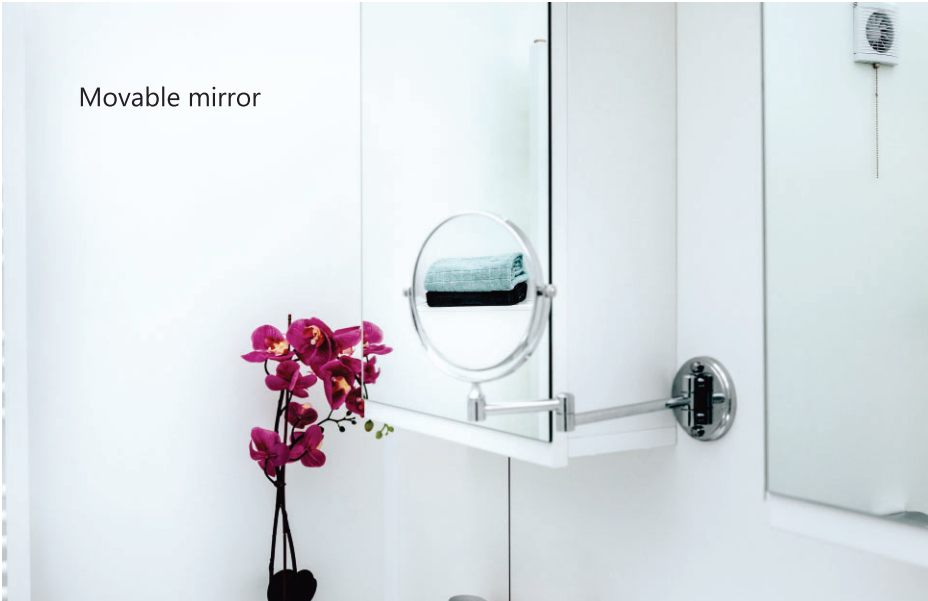

# Lark SaniModule OASIS REGULAR

Combination of a shower cabin with a wall-hung toilet and a washbasin.

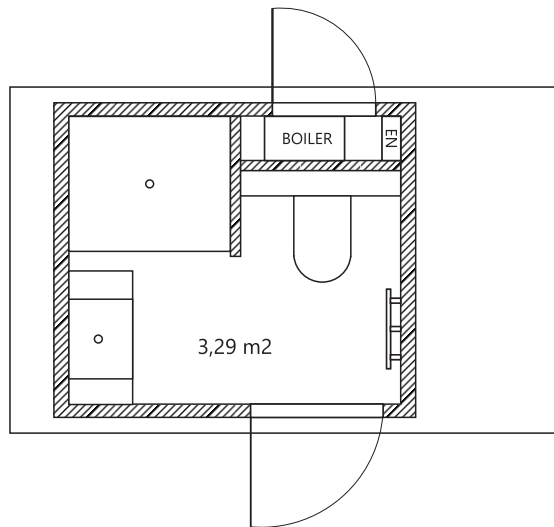

Wall: 2,0 x 2,3 m  
Roof: 2,2 x 3,5 m  
Height: 2,55 m

front

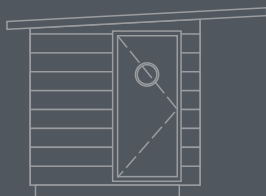

right



back



left



# Lark SaniModule OASIS PLUS

Combination of a shower cabin with a wall-hung toilet and a washbasin.

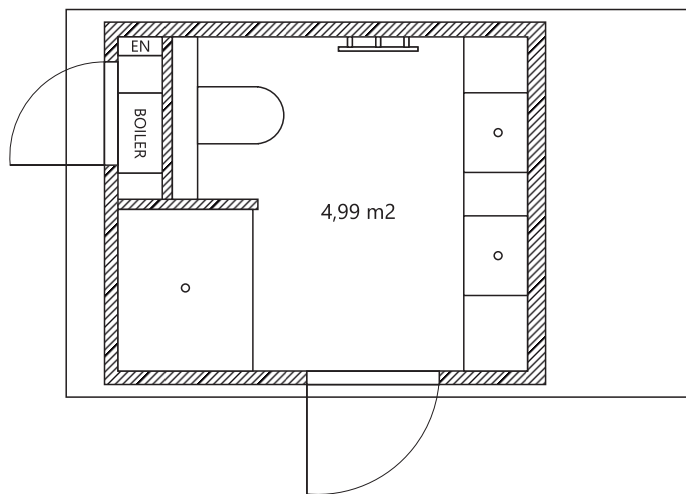

Wall: 2,3 x 2,8 m  
Roof: 2,5 x 4,0 m  
Height: 2,55 m



front



right



back

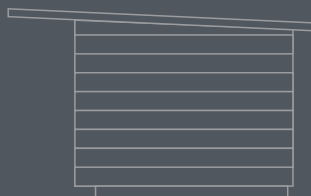

left

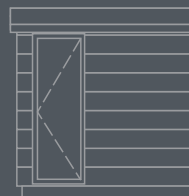

# Lark SaniModule OASIS DUO 1

The module is a combination of two separate toilets with washbasins and separate entrances from both sides.

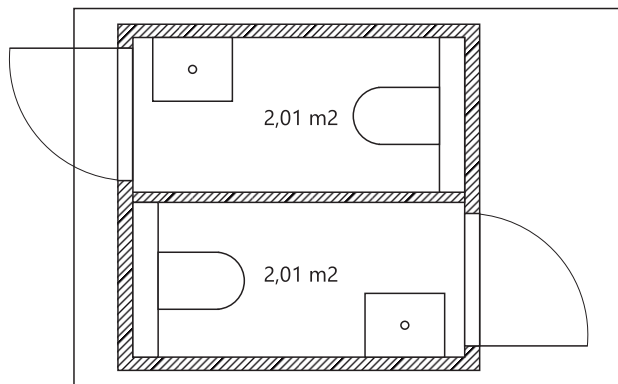

Wall: 2,3 x 2,3 m  
Roof: 2,5 x 3,5 m  
Height: 2,55 m

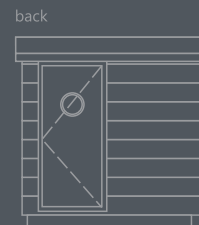
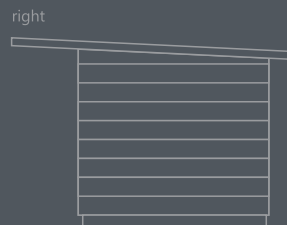
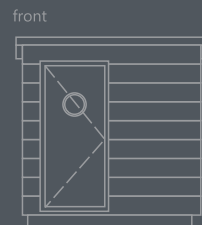
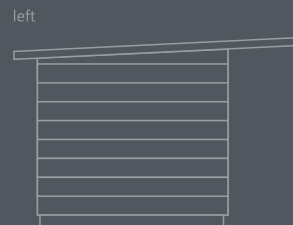

# Lark SaniModule OASIS DUO 2

The module is a combination of two separate toilets with washbasins and separate entrances from one sides.

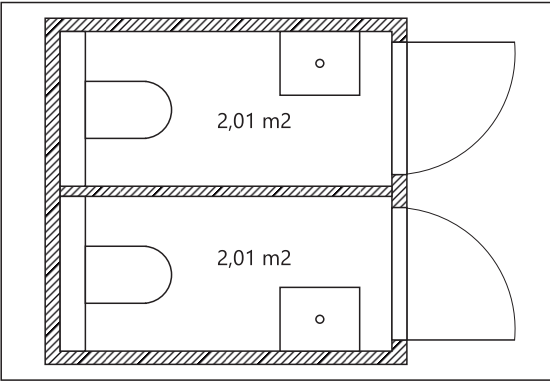

Wall: 2,3 x 2,3 m  
Roof: 2,5 x 3,5 m  
Height: 2,55 m

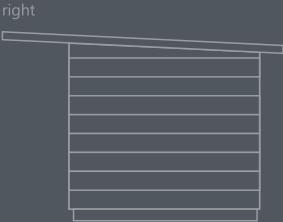
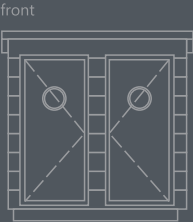
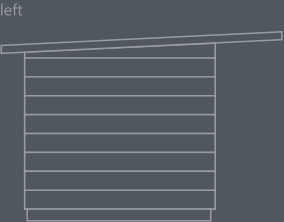

# Lark SaniModule OASIS COMPLEX

The module is a complex which includes two separate toilets, two separate showers and two separate washrooms.

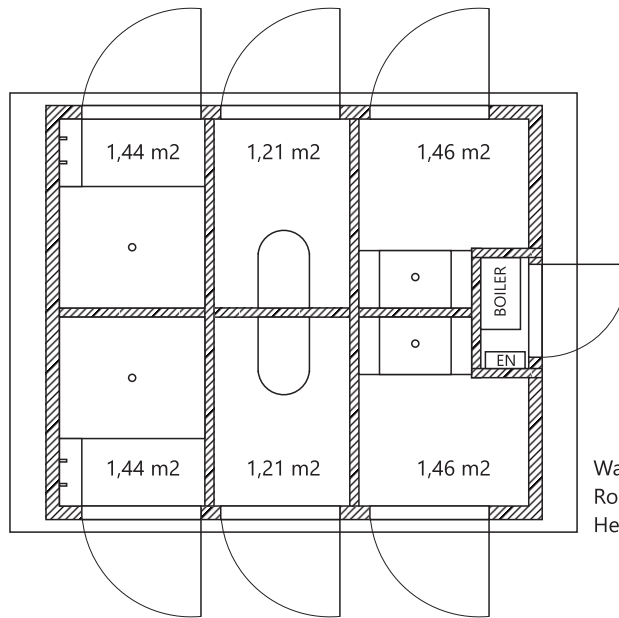

Wall: 3,0 x 3,5 m  
Roof: 3,2 x 4,0 m  
Height: 2,55 m

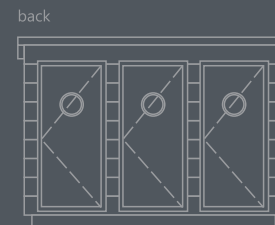
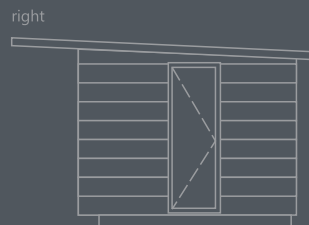
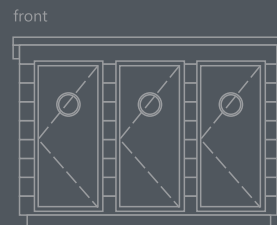
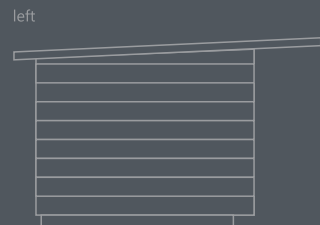

# Lark SaniModule OASIS

## ACCESS

The module is adapted to the needs of people with reduced mobility. Combination of a shower with toilet and sink and additionally equipped with a seat with a handrail.

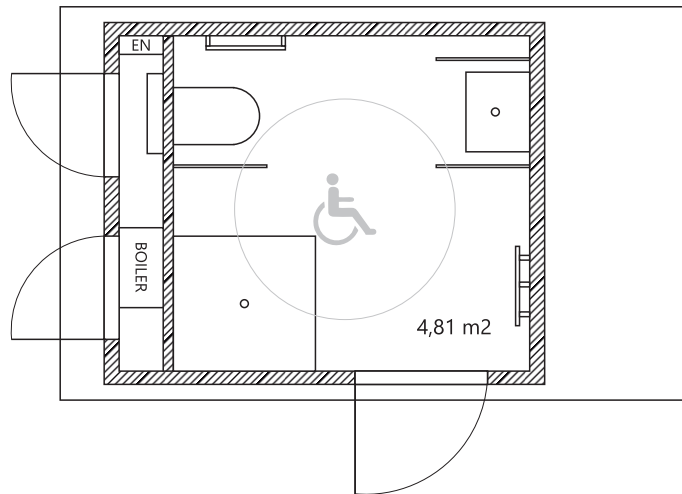

Wall: 2,3 x 2,8 m  
Roof: 2,5 x 4,0 m  
Height: 2,55 m



left

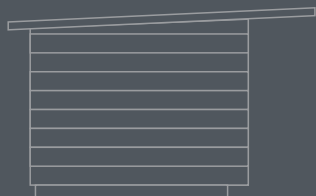

front

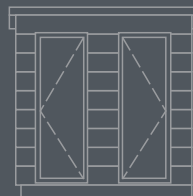

right

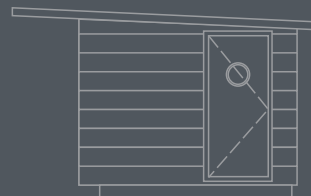

back



# Lark SaniModule OASIS PREMIUM 1

The module is a complex of two SaniModule models connected with a roof between. In this area there is a possibility to put two sinks.

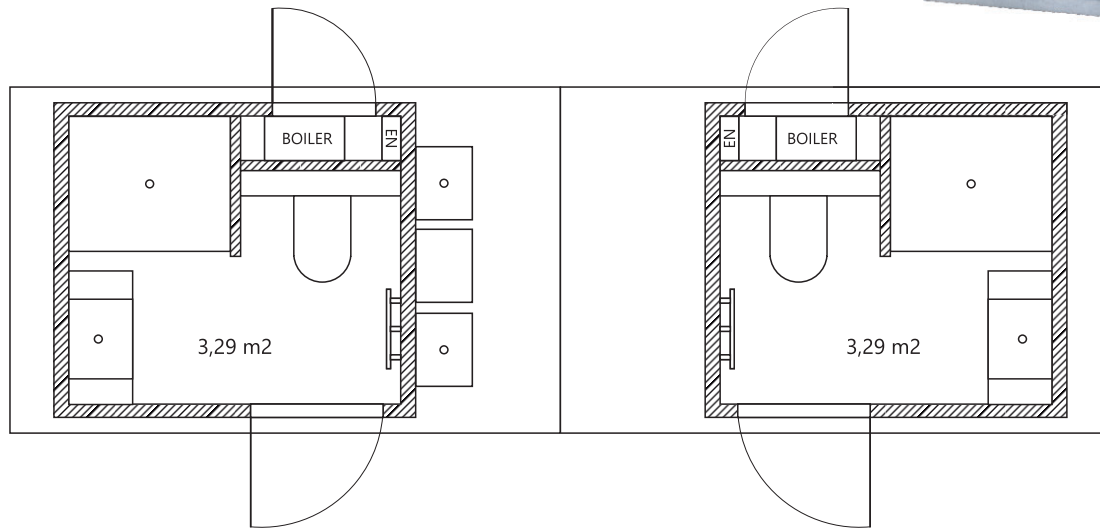

Wall: 2,0 x 2,3 m (1 module)  
Roof: 2,2 x 6,4 m  
Height: 2,55 m

left



front

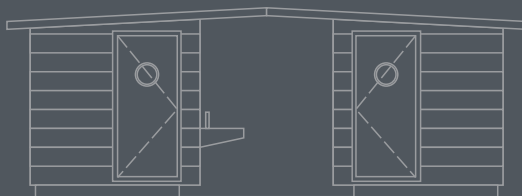

back

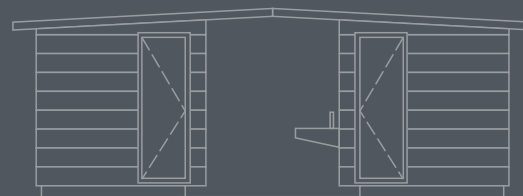

right





# Lark SaniModule OASIS PREMIUM 2

The module is a complex of two SaniModule models connected with a roof between. In this area there is a possibility to put three washbasins.

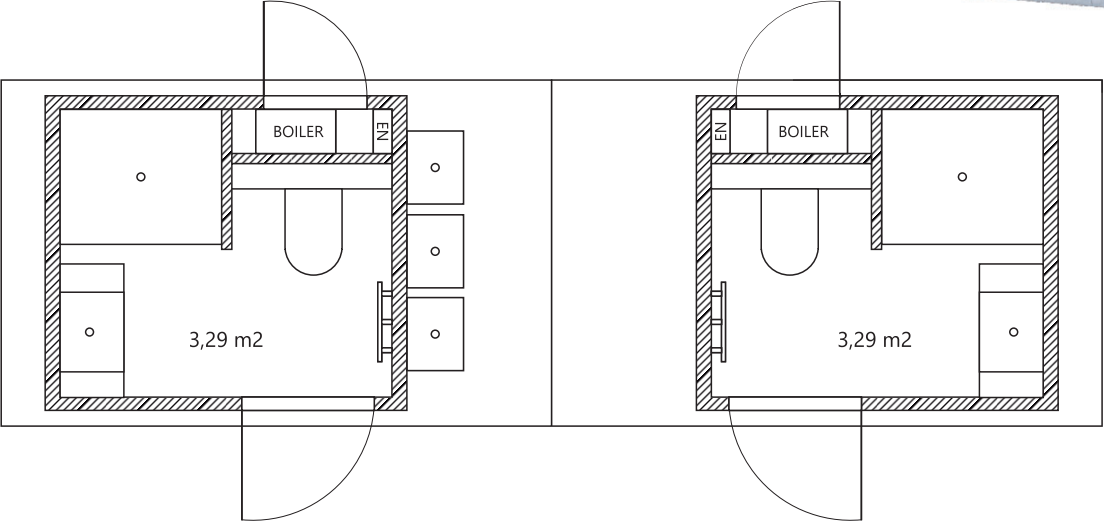

Wall: 2,0 x 2,3 m (1 module)  
Roof: 2,2 x 6,4 m  
Height: 2,55 m

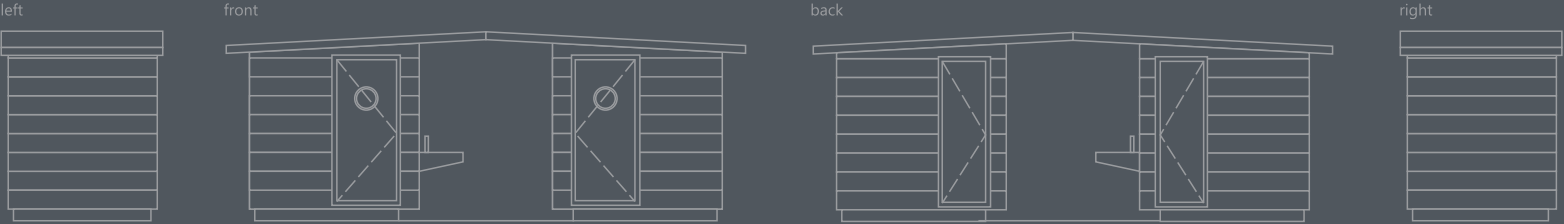

# Lark SaniModule OASIS PREMIUM 3

The module is a complex of two SaniModule models connected with a roof between. In this area there is a possibility to put outside kitchen module.

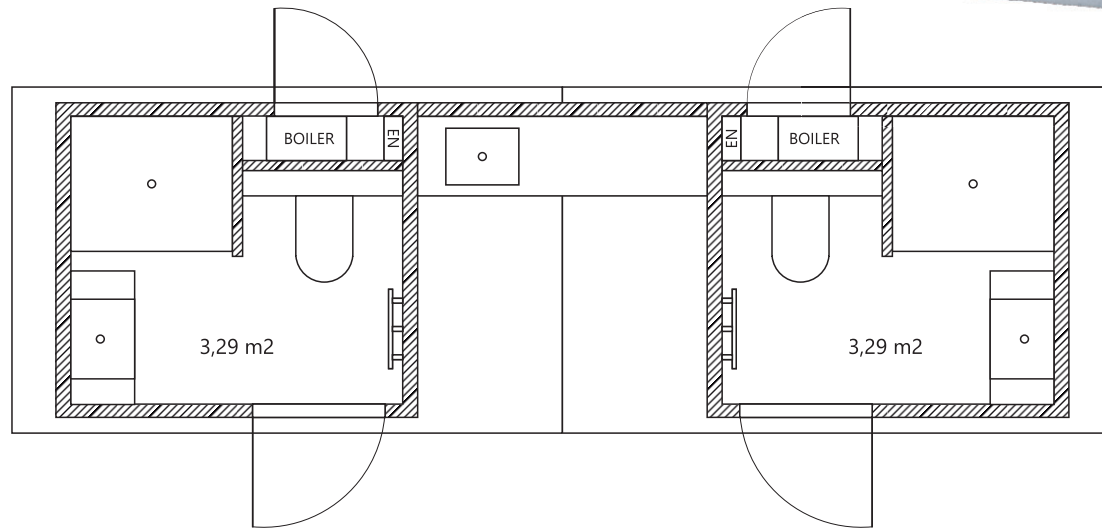

Wall: 2,0 x 2,3 m (1 module)  
Roof: 2,2 x 6,4 m  
Height: 2,55 m

left



front

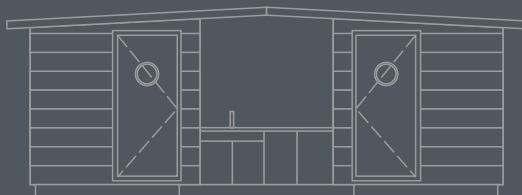

back

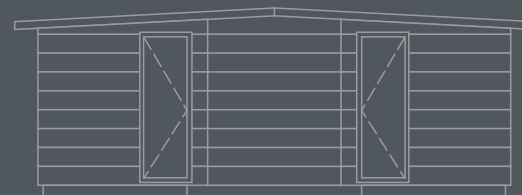

right



# Lark SaniModule OASIS PREMIUM 4

The module is a complex of two SaniModule models with extra roof between. In this area there is a possibility to put two sinks.

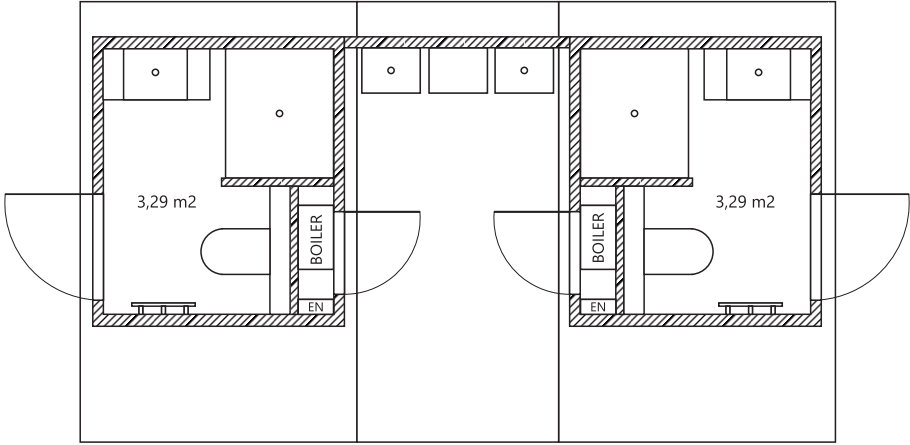

Wall: 2,0 x 2,3 m (1 module)  
Roof: 3,5 x 5,6 m  
Height: 2,55 m

left



front

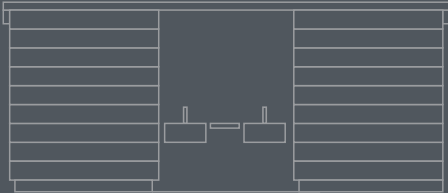

right



back

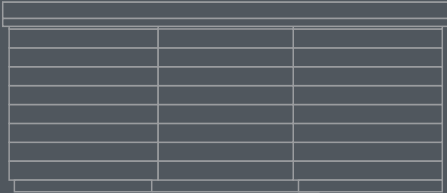

# Lark SaniModule OASIS PREMIUM 5

The module is a complex of two SaniModule models with extra roof between. In this area there is a possibility to put two waschbasins.

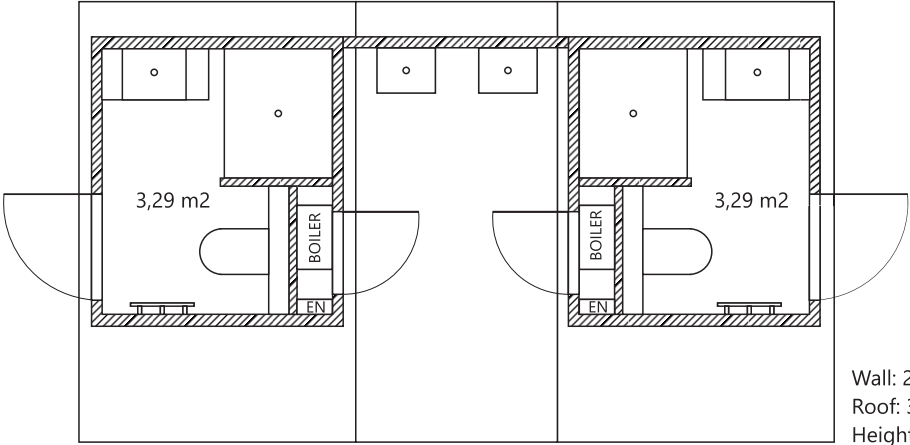

Wall: 2,0 x 2,3 m (1 module)  
Roof: 3,5 x 5,6 m  
Height: 2,55 m

left



front

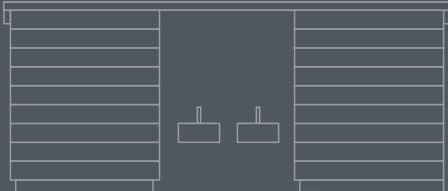

right

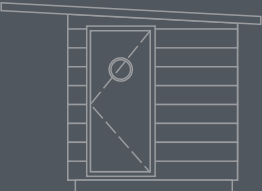

back

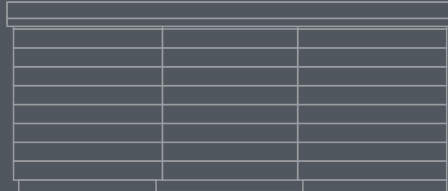

# Lark SaniModule OASIS SHOWER

The module includes five shower cabins and five countertop washbasins with mirrors.

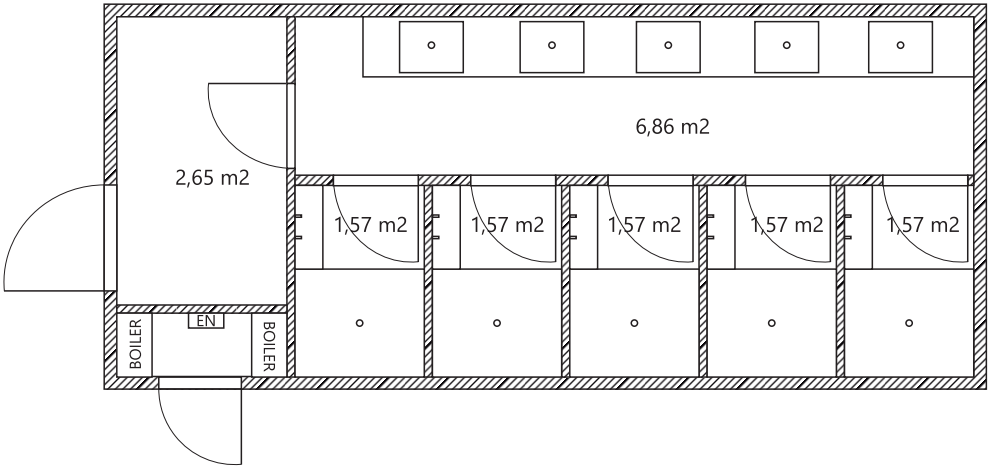

Wall: 3,0 x 7,0 m  
Roof: 3,2 x 7,5 m  
Height: 2,55 m

left



front



right

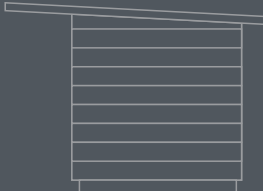

back



# Lark SaniModule OASIS TOILETS GENTELMAN

The module is a gentlemen toilet complex and includes five toilet cabins, four urinals and two countertop washbasins with mirrors.



Wall: 3,0 x 6,1 m  
Roof: 3,2 x 6,6 m  
Height: 2,55 m

29

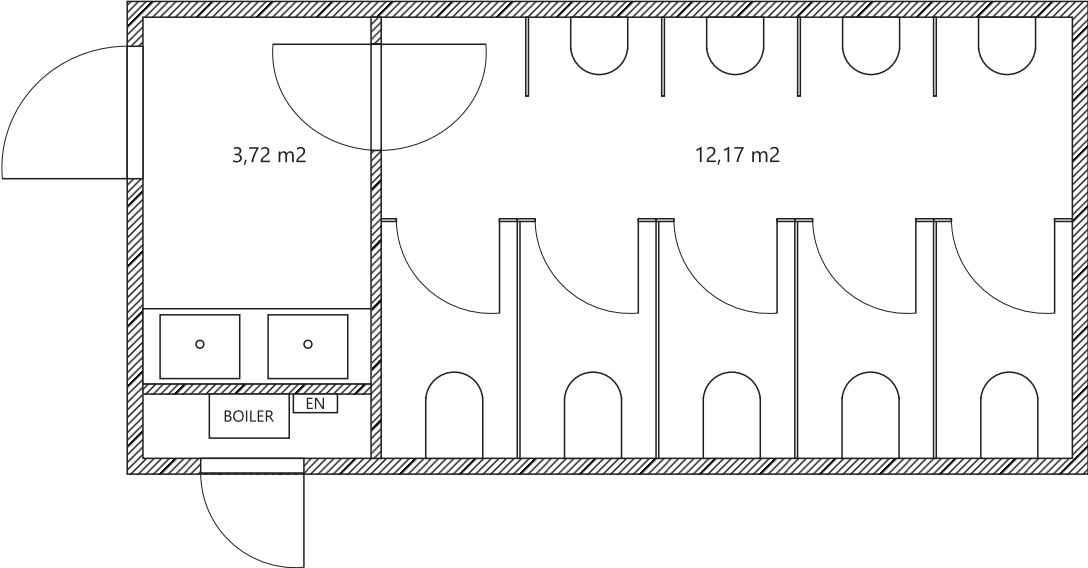

left



front



right

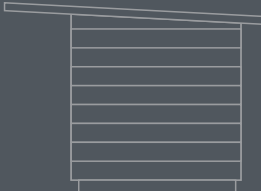

back



# Lark SaniModule OASIS LAIDIES TOILETS

The module is a ladies toilet complex and includes five toilet cubicles and five countertop washbasins with mirrors.

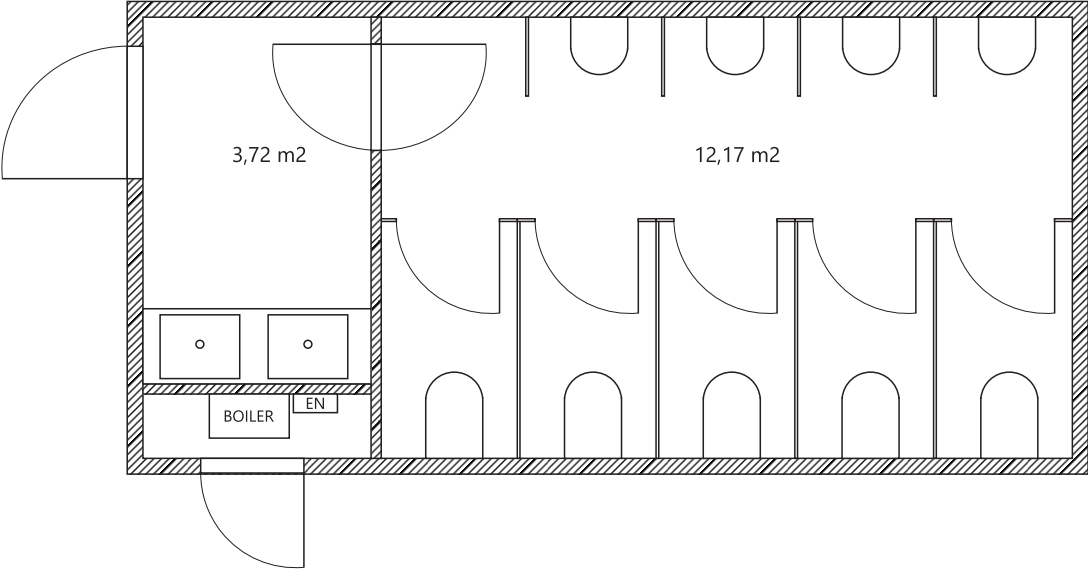

Wall: 3,0 x 6,1 m  
Roof: 3,2 x 6,6 m  
Height: 2,55 m

left



front



right

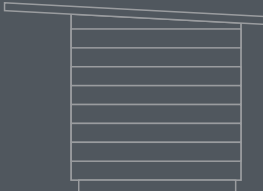

back



# Lark SaniModule OASIS KITCHEN DUO 1

This module has an access from both sides. Kitchen is open by external roller shutter. It includes a sink and electric cooker. There are shelves above and below worktop.

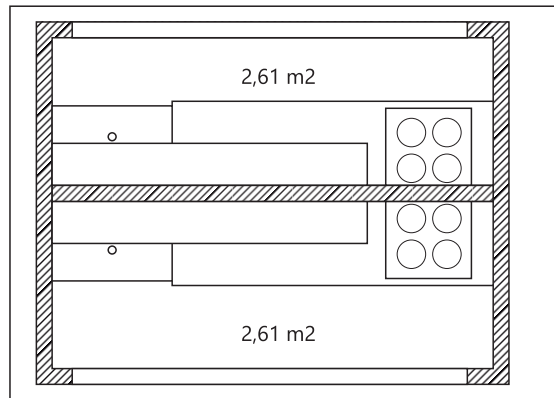

Wall: 2,3 x 3,0 m  
Roof: 2,5 x 3,5 m  
Height: 2,55 m

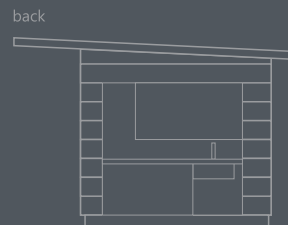
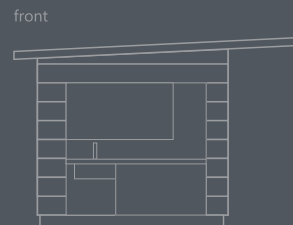



# Lark SaniModule OASIS KITCHEN DUO 2

This module has an access from both sides. Kitchen is closed by external roller shutter. It includes a sink and electric cooker. There are shelves above and below worktop.

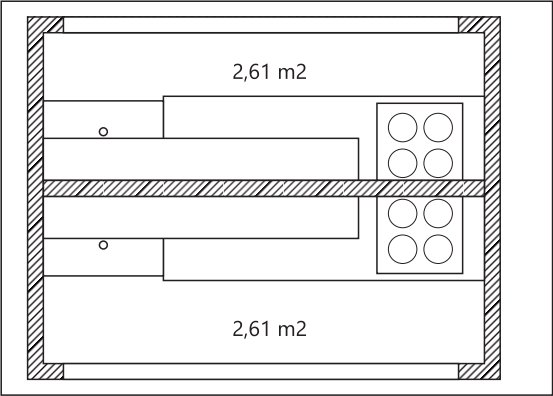

Wall: 2,3 x 3,0 m  
Roof: 2,5 x 3,5 m  
Height: 2,55 m



front

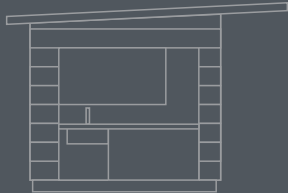

right

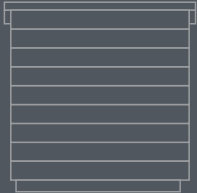

back

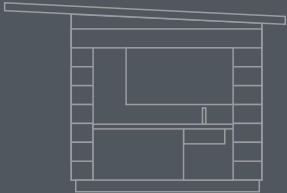

left

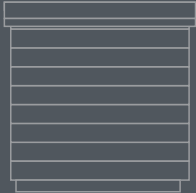

# Lark SaniModule OASIS

## KITCHEN 1

The kitchen module is open. It includes a sink and electric cooker. There are shelves above and below worktop.

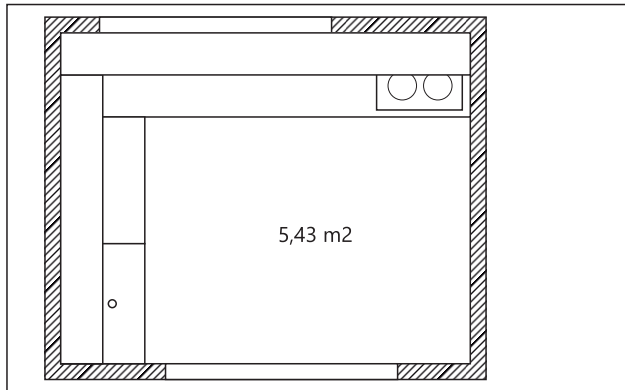

Wall: 2,3 x 2,8 m  
Roof: 2,5 x 4,0 m  
Height: 2,55 m

front

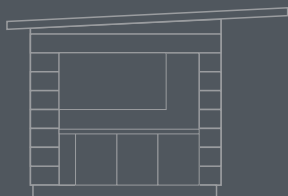

right



back

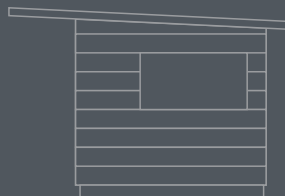

left



# Lark SaniModule OASIS

## KITCHEN 2

The kitchen module is closed by external roller shutter. It includes a sink and electric cooker. There are shelves above and below worktop.

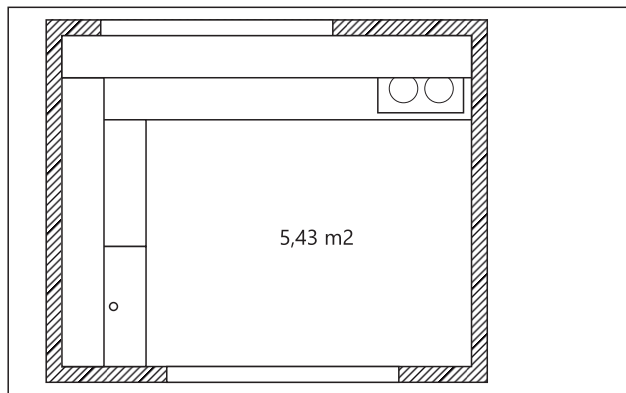

Wall: 2,3 x 2,8 m  
Roof: 2,5 x 4,0 m  
Height: 2,55 m

front

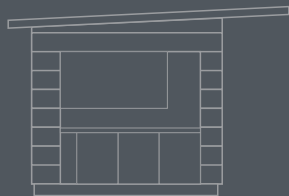

right

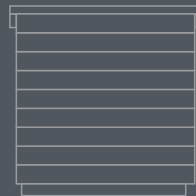

back

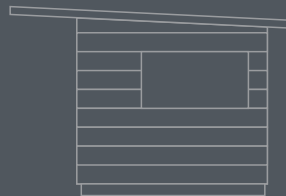

left

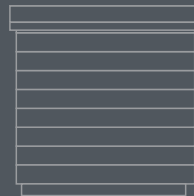

# Lark SaniModule OASIS

## KITCHEN 3

The kitchen module is closed by sliding doors. It includes a sink and electric cooker. There are shelves above and below worktop.

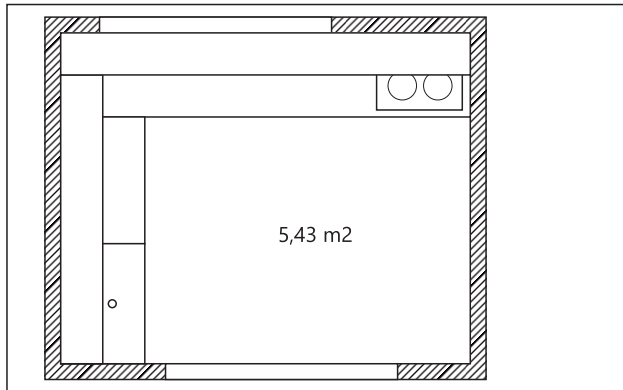

Wall: 2,3 x 2,8 m  
Roof: 2,5 x 4,0 m  
Height: 2,55 m

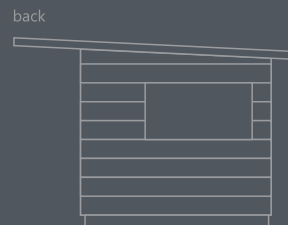
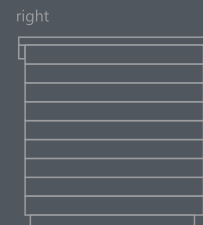
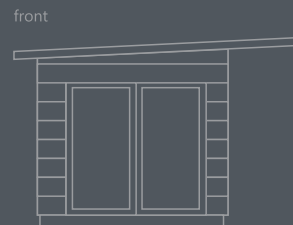

# Lark SaniModule OASIS

## KITCHEN ACCESS 1

The module is adapted to the needs of people with reduced mobility. The kitchen is open. Kitchen includes electric cooker, under-counter fridge and sink. All shelves are designed with easy access for wheelchair users.

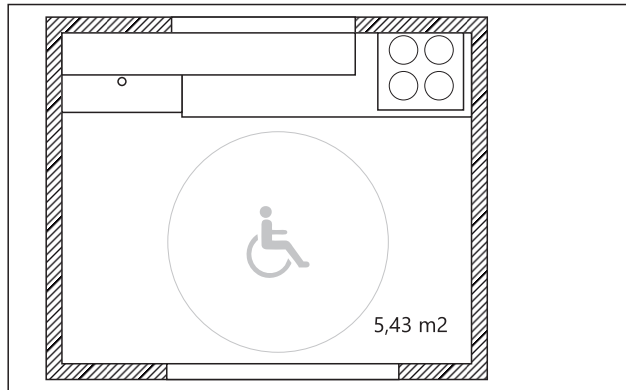

Wall: 2,3 x 2,8 m  
Roof: 2,5 x 4,0 m  
Height: 2,55 m



front

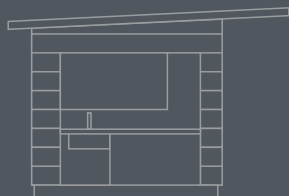

right



back

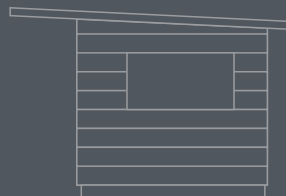

left



# Lark SaniModule OASIS

## KITCHEN ACCESS 2

The module is adapted to the needs of people with reduced mobility. The kitchen module is closed by external roller shutter. Kitchen includes electric cooker, under-counter fridge and sink. All shelves are designed with easy access for wheelchair users.

37

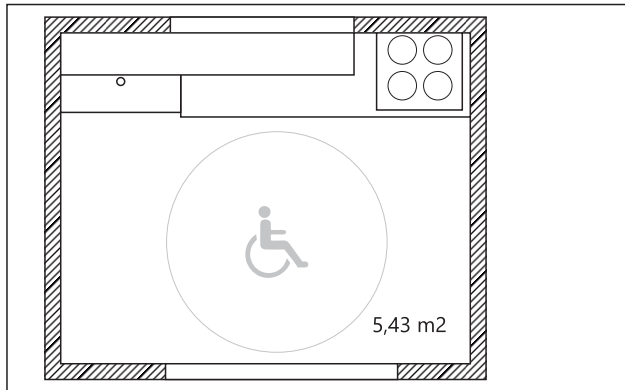

Wall: 2,3 x 2,8 m  
Roof: 2,5 x 4,0 m  
Height: 2,55 m

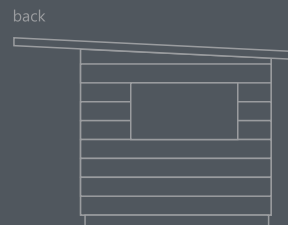
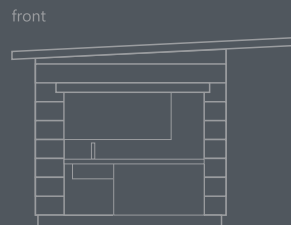

# Lark SaniModule OASIS

## KITCHEN ACCESS 3

The module is adapted to the needs of people with reduced mobility. The kitchen module is closed by sliding doors. Kitchen includes electric cooker, under-counter fridge and sink. All shelves are designed with easy access for wheelchair users.

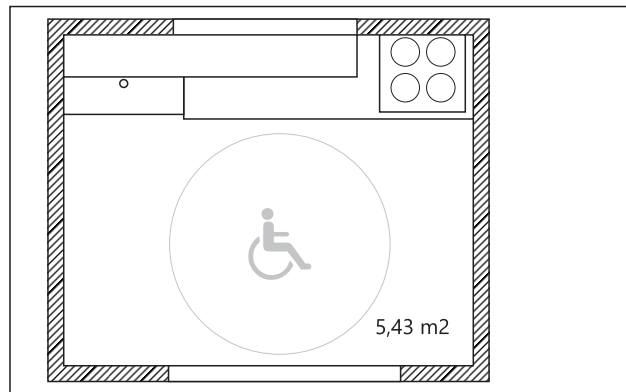

Wall: 2,3 x 2,8 m  
Roof: 2,5 x 4,0 m  
Height: 2,55 m



front

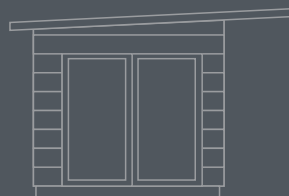

right



back

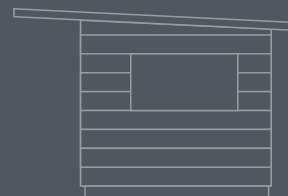

left



# Lark SaniModule OASIS HABITAT 1

The habitat module was designed as a guesthouse which contains a bed and a workspace.

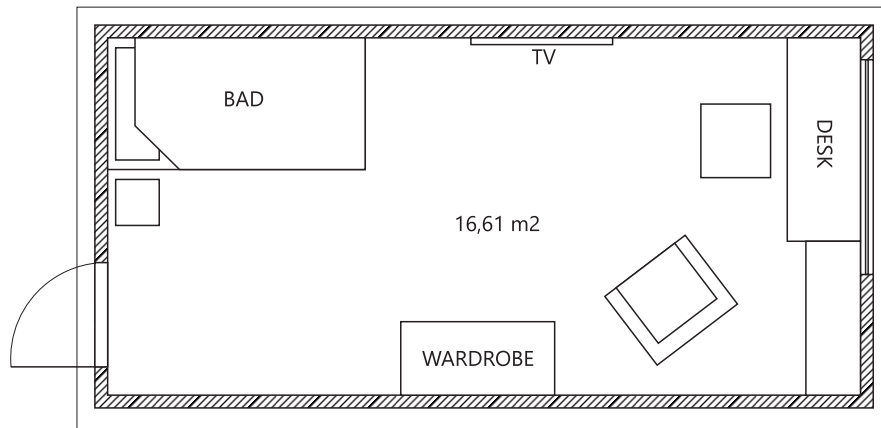

Wall: 3,0 x 6,1 m  
Roof: 3,2 x 6,3 m  
Height: 2,55 m

left

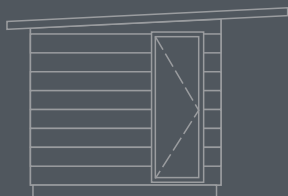

front



right

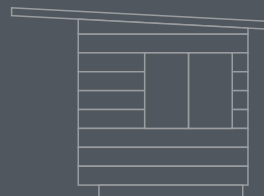

back





# Lark SaniModule OASIS HABITAT 2

The habitat module was designed as a guesthouse which contains a bed and a workspace.

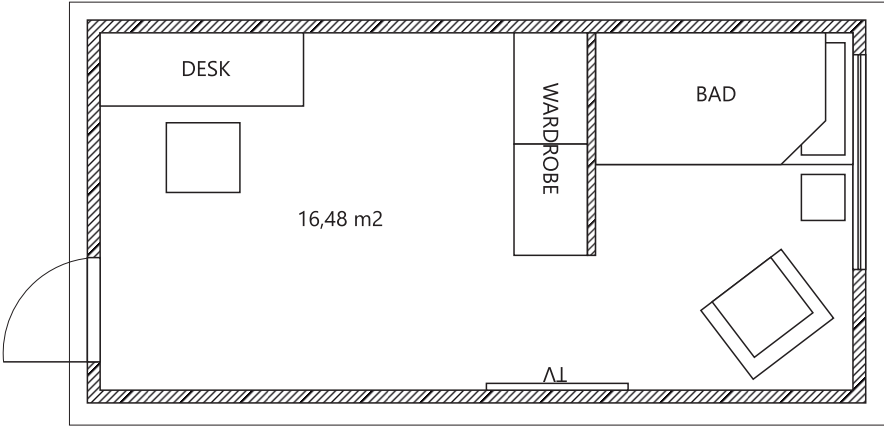

Wall: 3,0 x 6,1 m  
Roof: 3,2 x 6,3 m  
Height: 2,55 m

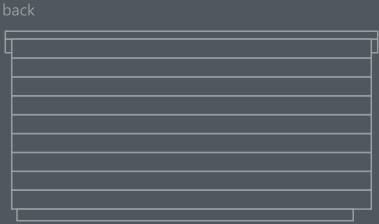
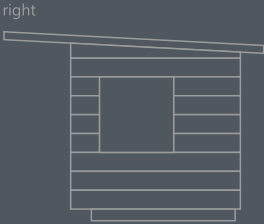
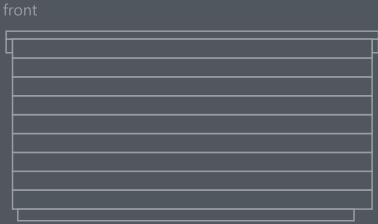
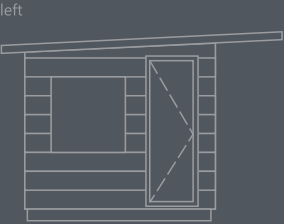

# Lark SaniModule OASIS HABITAT COUPLE 1

The habitat module was designed as a guesthouse which contains a bed and a workspace.

41

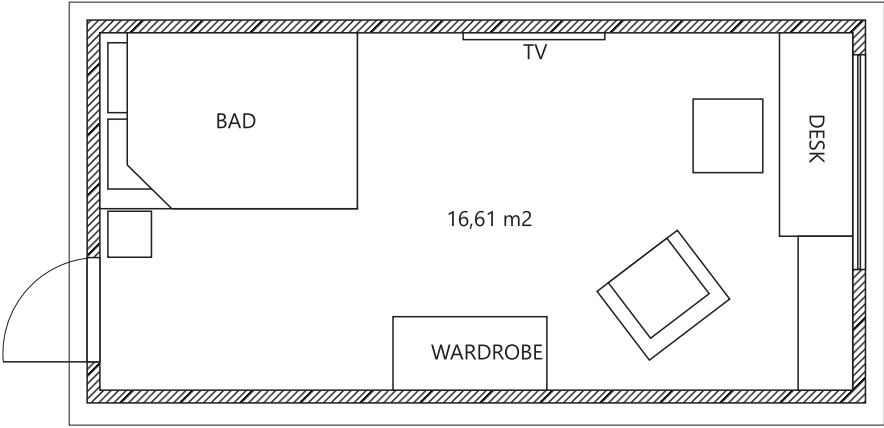

Wall: 3,0 x 6,1 m  
Roof: 3,2 x 6,3 m  
Height: 2,55 m

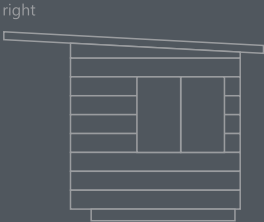
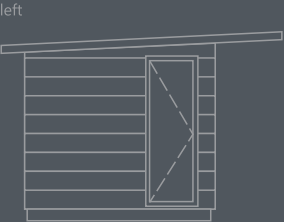

# Lark SaniModule OASIS HABITAT COUPLE 2

The habitat module was designed as a guesthouse which contains a bed and a workspace.

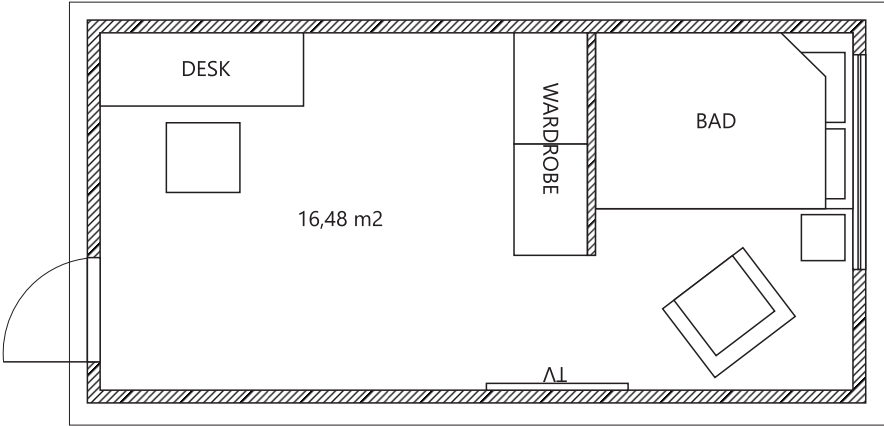

Wall: 3,0 x 6,1 m  
Roof: 3,2 x 6,3 m  
Height: 2,55 m

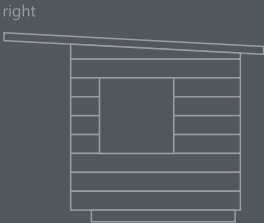
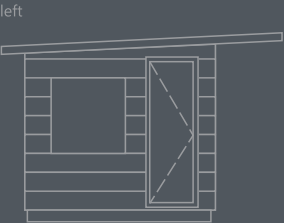

# Lark SaniModule OASIS HABITAT COUPLE 3

The habitat module was designed as a guesthouse which contains a bed and a workspace.



Wall: 3,0 x 6,1 m  
Roof: 3,2 x 6,3 m  
Height: 2,55 m

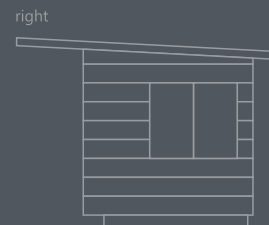
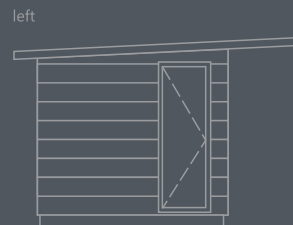
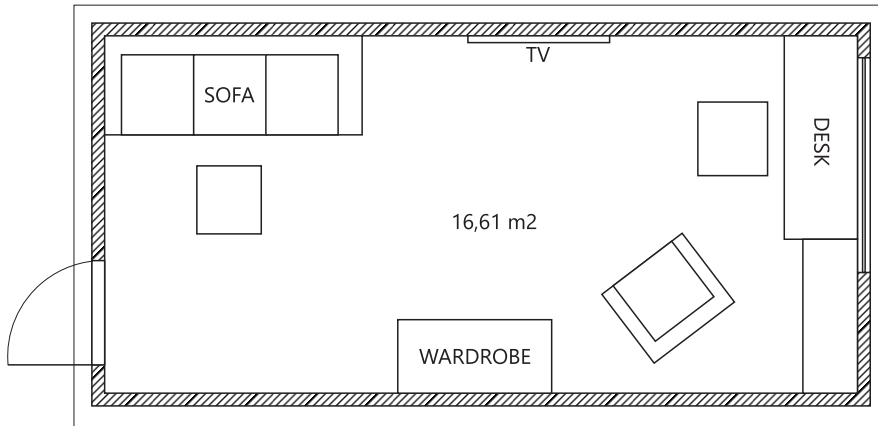

# Lark SaniModule OASIS HABITAT COUPLE 4

The habitat module was designed as a guesthouse which contains a bed and a workspace.

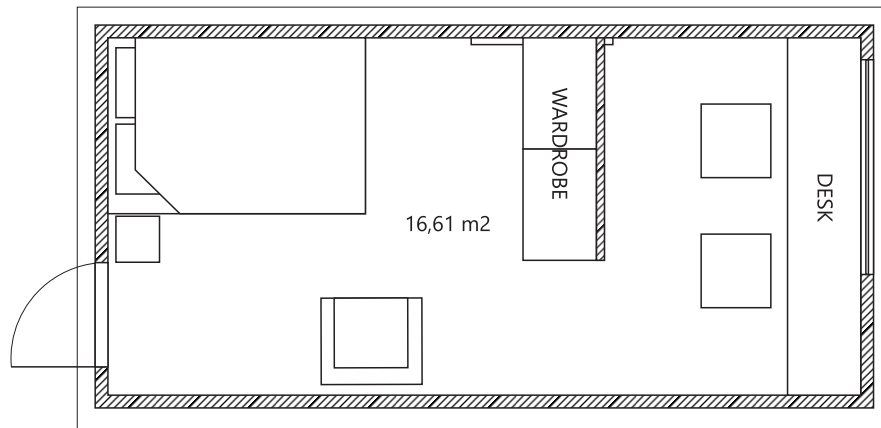

Wall: 3,0 x 6,1 m  
Roof: 3,2 x 6,3 m  
Height: 2,55 m

left

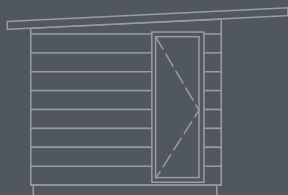

front



right

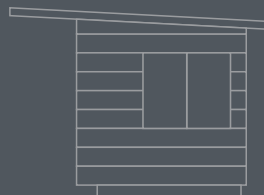

back



# Lark SaniModule OASIS CANTEEN

The canteen module is open. It includes two shelves.

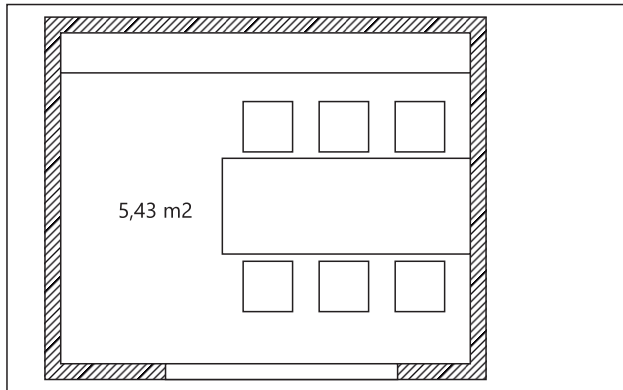

Wall: 2,3 x 2,8 m  
Roof: 2,5 x 4,0 m  
Height: 2,55 m

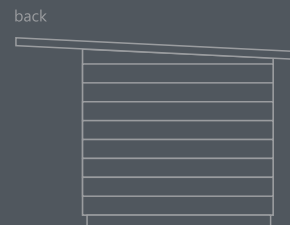
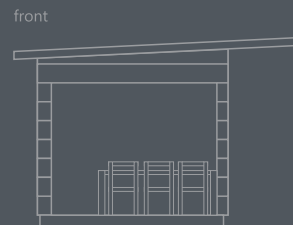

# Lark SaniModule OASIS

## OPEN WORK

The canteen module is open. Walls are an openwork design. It includes two shelves.

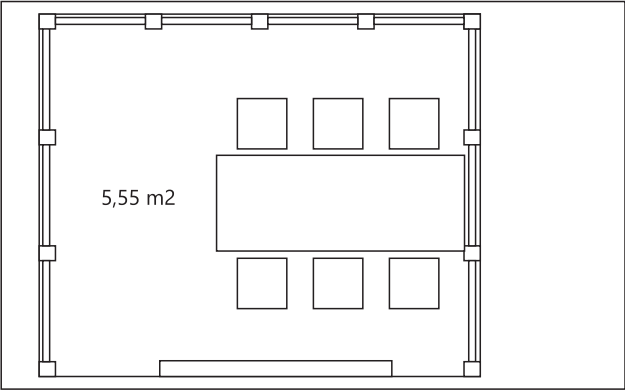

Wall: 2,3 x 2,8 m  
Roof: 2,5 x 4,0 m  
Height: 2,55 m

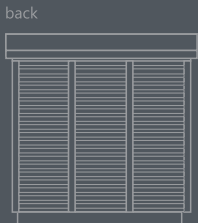
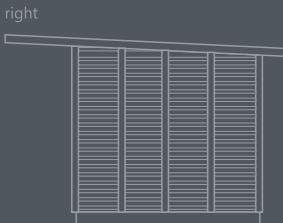
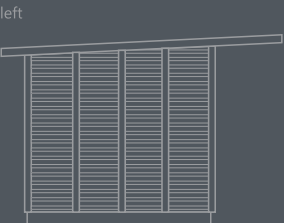

# Lark SaniModule OASIS

## EXEMPLARY CONNECTION OF MODULES

47

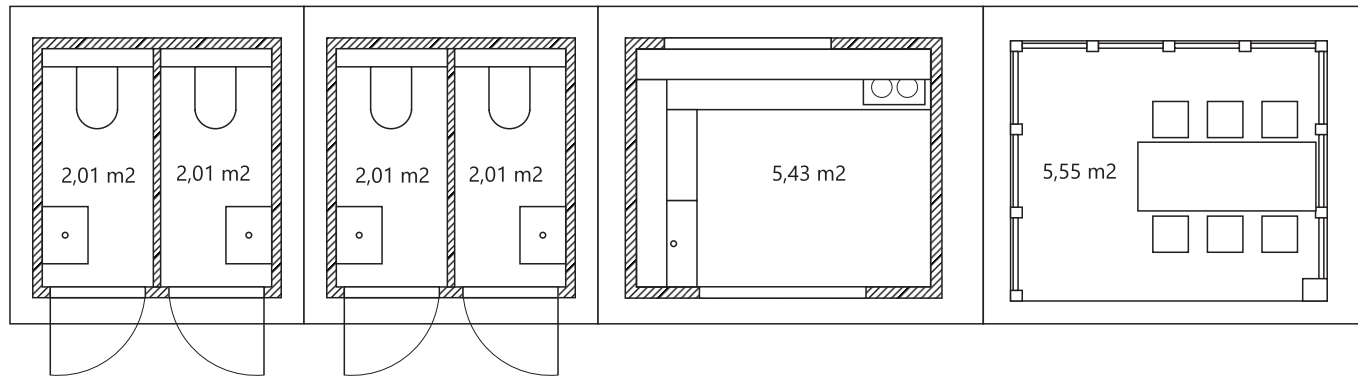

left

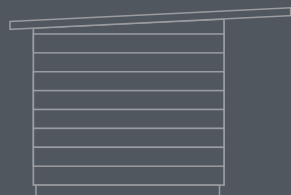

front

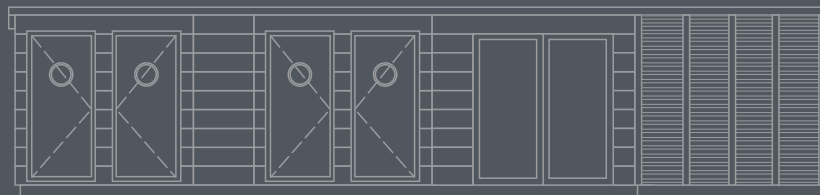

right

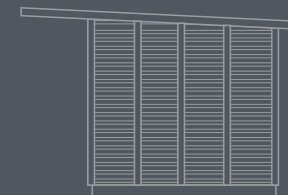

back

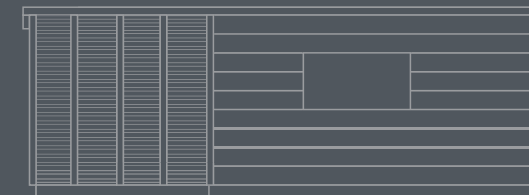



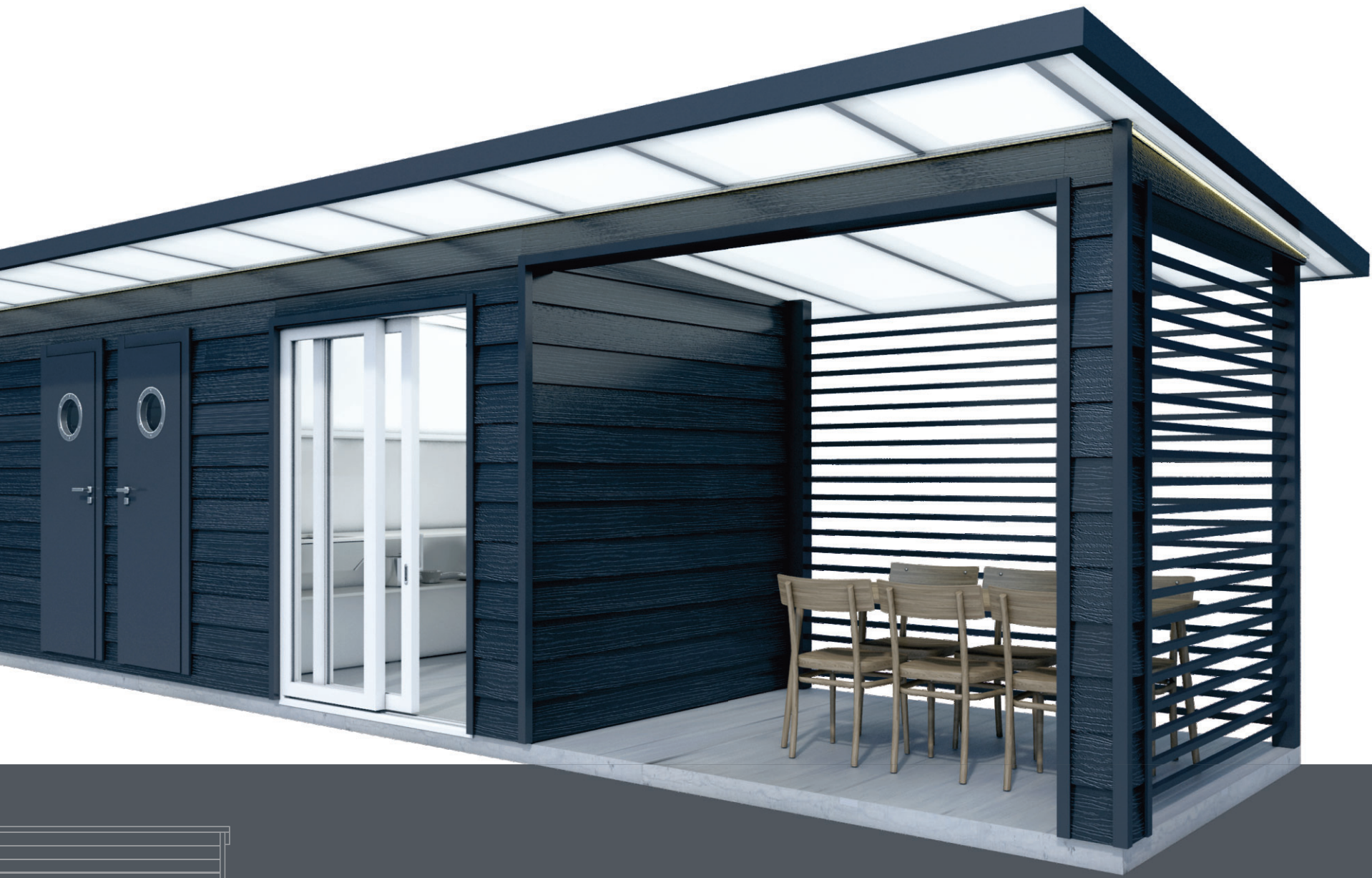

# Lark SaniModule OASIS

## EXEMPLARY CONNECTION OF MODULES

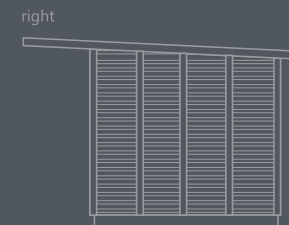
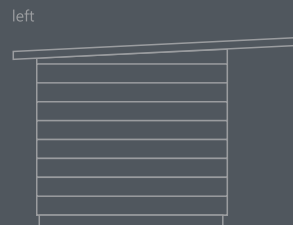
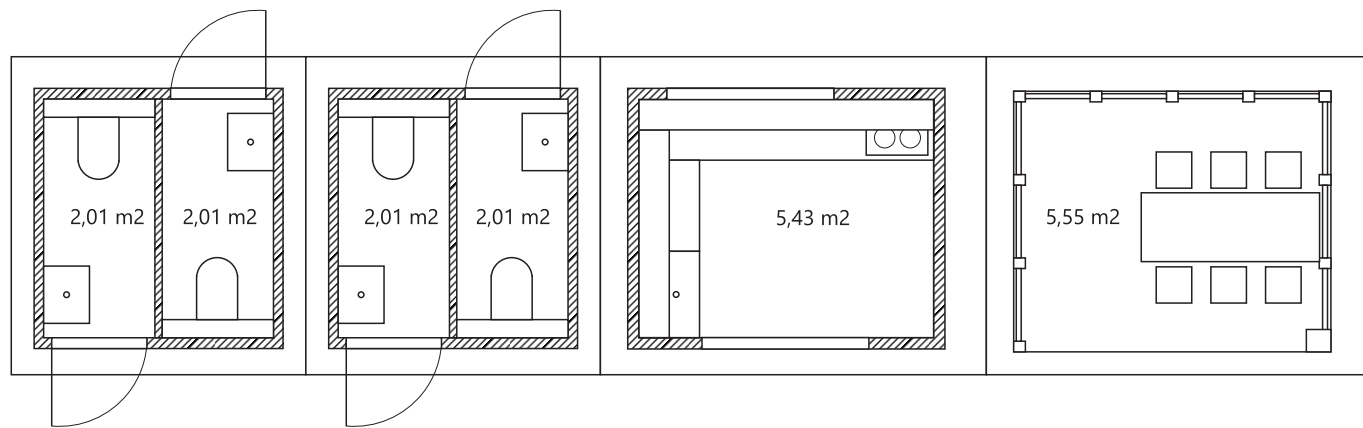

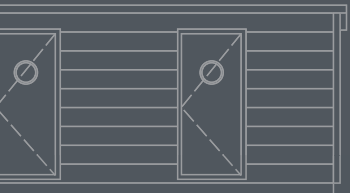

# Lark SaniModule OASIS

## EXEMPLARY CONNECTION OF MODULES

51

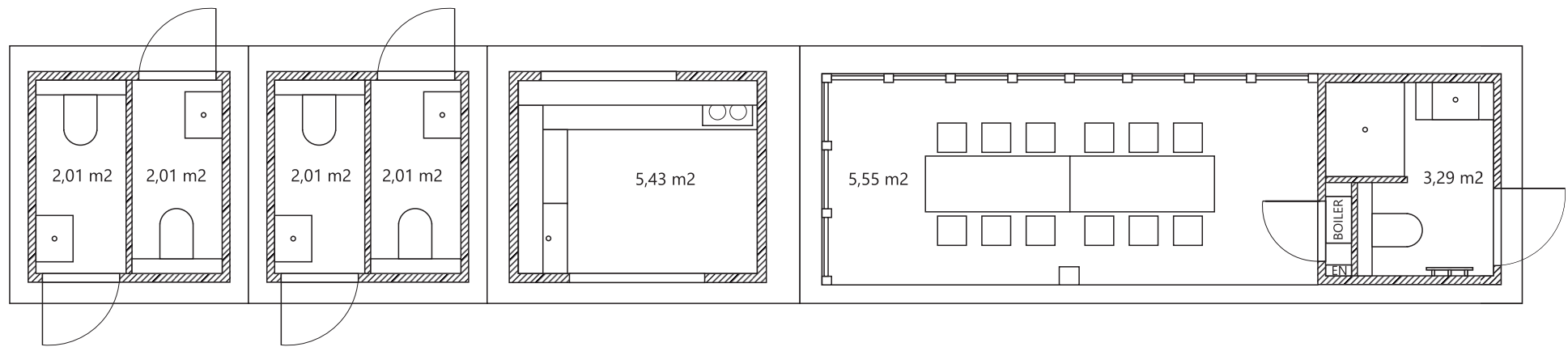

left

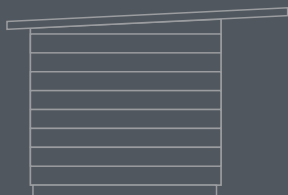

front

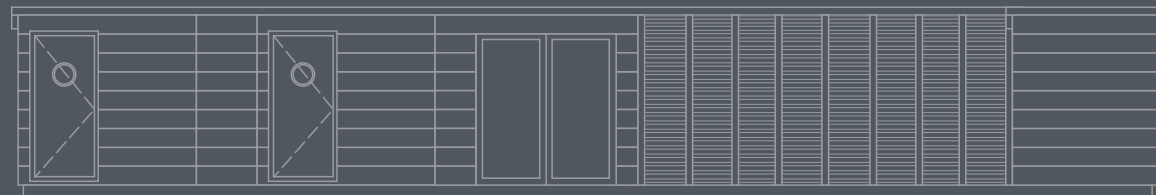

right

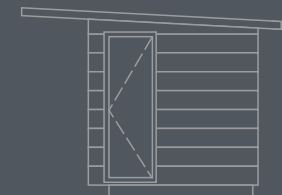

back





# About us

For many years, we have been a leading producer of high-quality mobile homes in timber-framed technology. Due to the high quality of the products we offer, we have become the main importer of mobile homes to the central and western Europe. At this moment, the Mobile Homes Factory Lark Leisure Homes supplies hundreds of campsites and learn about their needs and requirements.

This is why the idea for the production of sanitary modules appeared, which will in no doubt adapt to the high standards of campsites and the expectations of the clients of tourist facilities across Europe.



**Address**  
ul. Generała Sowińskiego 12A  
76-150 Darłowo

**Office**  
Phone: 94 314 9700  
biuro@larkfactory.com

**Sales Department**  
Phone: 94 314 9710  
handlowy@larkfactory.com

See also our range of Mobile Homes



